

The wise choice



Micro-Tronics

for all your filter needs

Micro-Tronics is an operating division of O.M. Jones, Inc.

Telephone: 209-532-1008

Facsimile: 209-532-1009

e-mail: sales@micro-tronics.net

-Model BPC50411

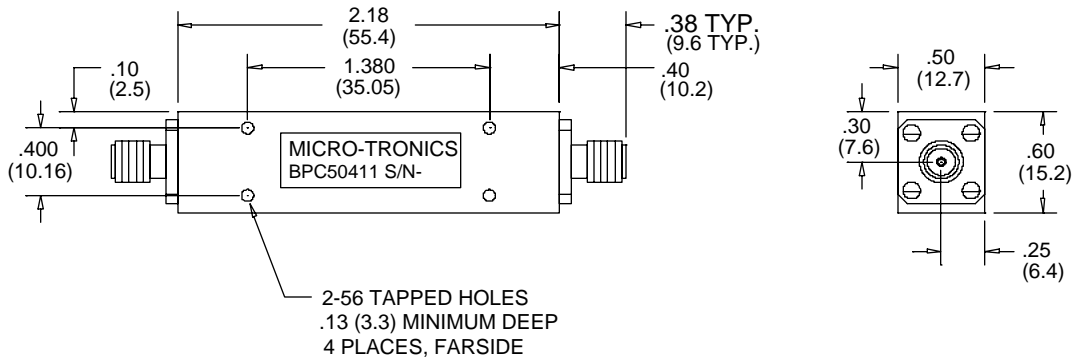

DIMENSIONS IN INCHES (MM)

Micro-Tronics Model BPC50411 was specifically designed to pass 12.0 to 18.0GHz while maintaining low insertion loss and sharp rejection. The basic bandpass filter design can also be adapted to custom applications.

Specifications:	
Passband (GHz)	12.0 to 18.0
Passband Insertion Loss:	1.0 dB maximum
Passband VSWR:	1.6:1 maximum
Stopband:	50 dB min from 0 to 10.5 and 19.0 to 26.5 GHz
Operating Power:	2W max

Connectors:

Model #:

BPC50411:	SMA Female – SMA Female
BPC50411-01:	SMA Male – SMA Female
BPC50411-02:	SMA Female – SMA Male
BPC50411-03:	SMA Male – SMA Male